



DSP7

DIRECTIONAL VALVES PILOT OPERATED, SOLENOID OR HYDRAULIC (DSC7) ACTUATED

**SUBPLATE MOUNTING
ISO 4401-07**

**p max 350 bar
Q max 300 l/min**

MOUNTING SURFACE

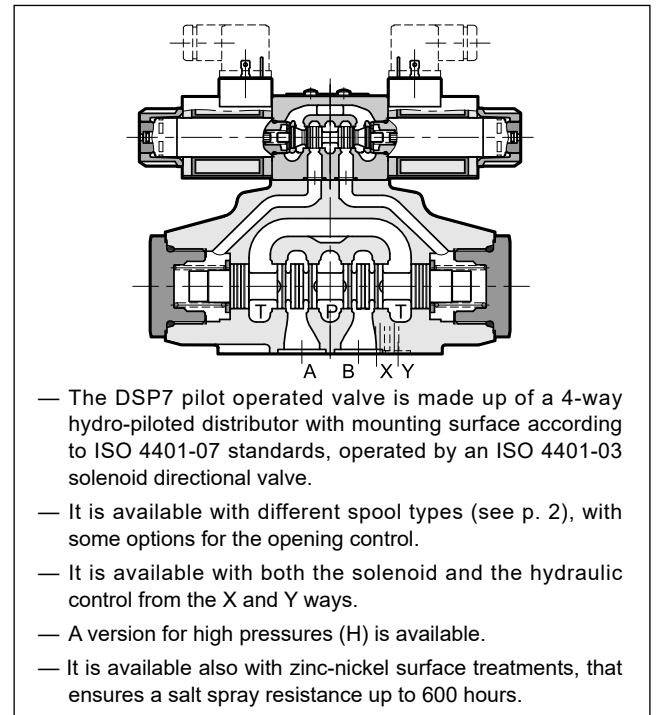
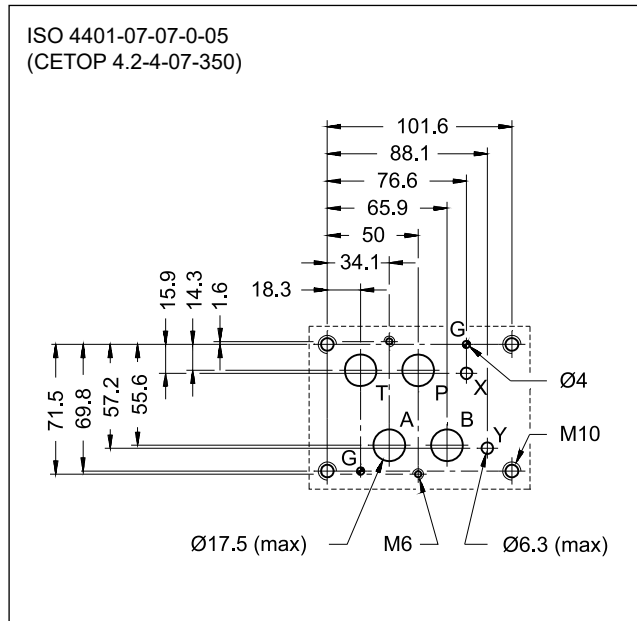

PERFORMANCES

(obtained with mineral oil of viscosity of 36 cSt at 50°C)

		DSP7	DSP7H
Maximum operating pressure			
- ports P - A - B	bar	350	420
- port T (external drainage)		250	350
- port T (internal drainage)		210 (DC) / 160 (AC)	210 (DC) / 160 (AC)
Maximum flow rate from port P to A - B - T	l/min	300	
Ambient temperature range	°C	-20 / +50	
Fluid temperature range	°C	-20 / +80	
Fluid viscosity range	cSt	10 ÷ 400	
Fluid contamination degree		according to ISO 4406:1999 class 20/18/15	
Recommended viscosity	cSt	25	
Mass:			
DSP7-S, RK	kg	8.6	
DSP7-T*, SA*, SB*		8.0	
DSC7		6.6	

1 - IDENTIFICATION CODE FOR DSP7 SOLENOID ACTUATED DIRECTIONAL VALVES

D	S	P	7	-	/	20	-	/	/	/	/	/	/	/	/	/	/	/	/
----------	----------	----------	----------	---	---	-----------	---	---	---	---	---	---	---	---	---	---	---	---	---

Directional valve, solenoid actuated, pilot operated

Size: ISO 4401-07

Option: (omit for standard version)
H = high pressure version
 pmax = 420 bar

Spool type (see point 2)

S* **TA**
SA* **TB**
SB* **RK**

Series: (the overall and mounting dimensions remain unchanged from 20 to 29)

Seals:
N = NBR seals for mineral oil (**standard**)
V = FPM seals for special fluids

Piloting (see point 9):

I = internal (not available for spools S2 - S4 - S7 - S8 - TA02 - TB02 - RK02 - S*2 - S*4. If internal pilot is required, choose pilot type C)
C = internal piloting with backpressure valve
Z = internal piloting with 30 bar fixed adjustment pressure reducing valve (see point 8)
E = external

Drainage (see point 9):
I = Internal
E = External

Control options (see point 11):

C = Main spool stroke control
D = Main spool switching speed control
P08 = Subplate placed under solenoid valve with restrictor of Ø0.8 on port P
S2 = Distributor delivered with pilot solenoid valve with spool S2

Option:
 / **W7** = Zinc-nickel surface treatment (see **NOTE 2**)
 Omit if not required

Manual override:
 omit for override integrated in the tube (standard)
CM = manual override, boot protected (see point 17)

Coil electrical connection (see p. 15):
K1 = plug for connector type EN 175301-803 (ex DIN 43650) (**standard**)
K7 = plug DEUTSCH DT04-2P for male connector type DEUTSCH DT06-2S (available on D12 and D24 coils only)

Power supply (see point 11)

direct current

D12 = 12 V
D24 = 24 V
D48 = 48 V
D110 = 110 V
D220 = 220 V
D00 = valve without coils (see **NOTE 1**)

alternate current

A24 = 24 V - 50 Hz
A48 = 48 V - 50 Hz
A110 = 110 V - 50 Hz / 120 V - 60 Hz
A230 = 230 V - 50 Hz / 240 V - 60 Hz
A00 = valve without coils (see **NOTE 1**)
F110 = 110 V - 60 Hz
F220 = 220 V - 60 Hz

NOTE 1: Coils locking ring and related OR are supplied together with valves.

NOTE 2: The standard valve is supplied with surface treatment of phosphating black.

The zinc-nickel finishing on the valve body (both main and pilot) makes the valve suitable to ensure a salt spray resistance up to **240** hours (test operated according to UNI EN ISO 9227 standards and test evaluation operated according to UNI EN ISO 10289 standards).

For a salt spray resistance up to **600** hours refer to point 18.

2 - DSP7 SPOOL TYPES

Type S*:
2 solenoids - 3 positions
with spring centring

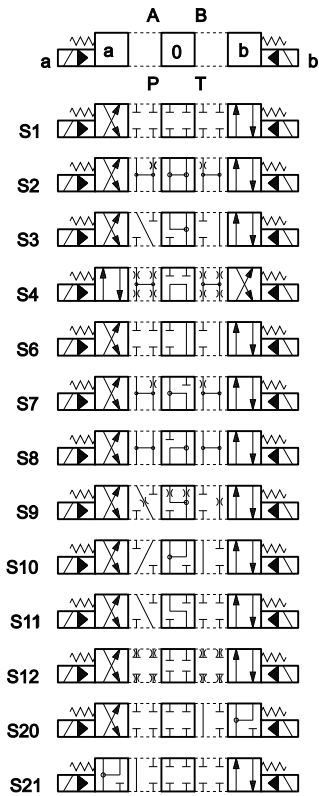

Type SA*:
1 solenoid side A
2 positions (central + external)
with spring centring

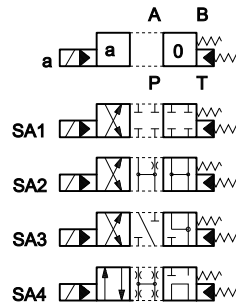

Type SB*:
1 solenoid side B
2 positions (central + external)
with spring centring

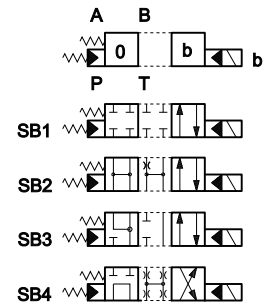

Type TA:
1 solenoid side A
2 external positions
with return spring

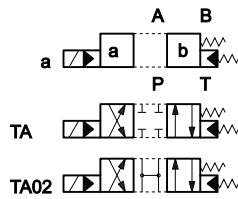

Type TB:
1 solenoid side B
2 external positions
with return spring

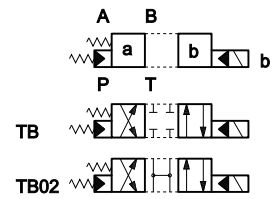

Type RK:
2 solenoids - 2 positions
with mechanical retention

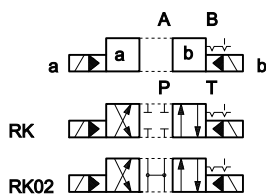

Type 23TA / 23TB
three-way valve - 1 solenoid - 2 external positions, return spring

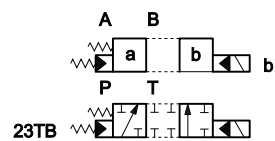
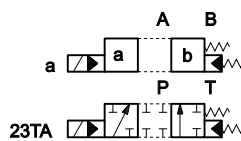

Besides the diagrams shown, special versions are available: consult our technical dept. for their identification, feasibility and operating limits.

3 - IDENTIFICATION CODE FOR DSC7 HYDRAULIC ACTUATED DIRECTIONAL VALVE

	D	S	C	7		-		/	10		-	E	E	
--	----------	----------	----------	----------	--	----------	--	----------	-----------	--	----------	----------	----------	--

Directional valve, hydraulic actuated pilot operated through X and Y ports.

Size: ISO 4401-07

Option:
(omit for standard version)
H = high pressure version
 $P_{max} = 420$ bar

Spool type (see point 2 and below)

S* **TA**
SA* **TB**
SB* **R**

Option:
/ **W7** = Zinc-nickel surface treatment (see **NOTE**)
Omit if not required

External drain (see p. 9)

External pilot (see p. 9)

Seals:
N = NBR seals for mineral oil (**standard**)
V = FPM seals for special fluids

Series: (the overall and mounting dimensions remain unchanged from 10 to 19)

Spool types

The distributor is delivered with short-circuit subplate. The X and Y ports are used for the hydraulic control of the valve.

DSC7-S*

DSC7-TA

DSC7-TB

NOTE: The standard valve is supplied with surface treatment of phosphating black.

The zinc-nickel finishing makes the valve suitable to ensure a salt spray resistance up to **600** hours. (test operated according to UNI EN ISO 9227 standards and test evaluation operated according to UNI EN ISO 10289 standards).

4 - HYDRAULIC FLUIDS

Use mineral oil-based hydraulic fluids HL or HM type, according to ISO 6743-4. For these fluids, use NBR seals (code N). For fluids HFDR type (phosphate esters) use FPM seals (code V).

For the use of other kinds of fluid such as HFA, HFB, HFC, please consult our technical department. Using fluids at temperatures higher than 80 °C causes a faster degradation of the fluid and of the seals characteristics.

The fluid must be preserved in its physical and chemical characteristics.

5 - PRESSURE DROPS ΔP -Q

(values obtained with viscosity 36 cSt at 50 °C)

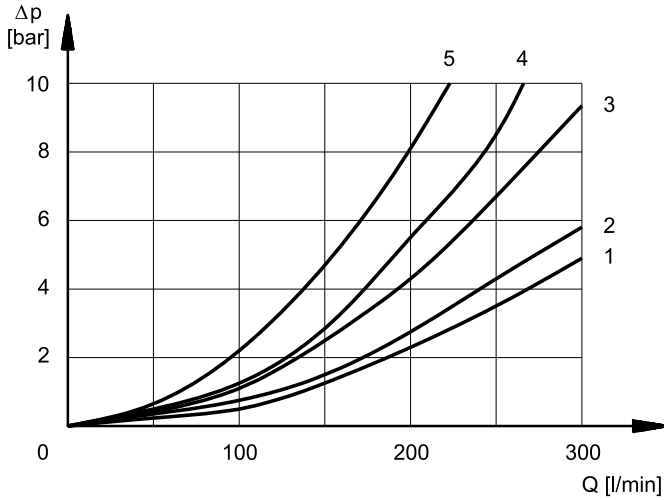

PRESSURE DROPS WITH VALVE ENERGIZED

SPOOL TYPE	FLOW DIRECTION			
	P-A	P-B	A-T	B-T
	CURVES ON GRAPH			
S1, SA1, SB1	1	1	3	4
S2, SA2, SB2	1	1	4	4
S3, SA3, SB3	1	1	4	4
S4, SA4, SB4	2	2	4	5
S6	1	1	3	4
S7	1	1	4	4
S8	1	1	3	4
S9	1	1	3	4
S10	1	1	3	4
S11	1	1	3	4
S12	1	1	3	4
S20	1	1	3	4
S21	1	1	4	4
TA, TB	1	1	3	4
TA02, TB 02	1	1	4	4
RK	1	1	3	4

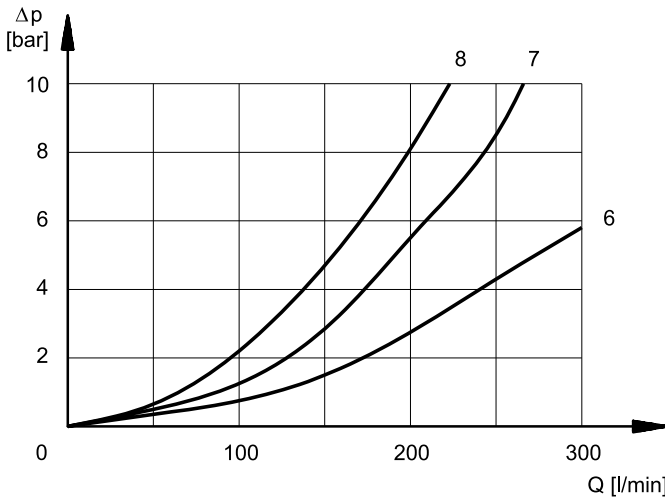

PRESSURE DROPS WITH VALVE IN DE-ENERGIZED POSITION

SPOOL TYPE	FLOW DIRECTION				
	P-A	P-B	A-T	B-T	P-T
	CURVES ON GRAPH				
S2, SA2, SB2					6
S3, SA3, SB3			7	7	
S4, SA4, SB4					7
S6				7	
S7					8
S8					8
S10			7	7	
S11			7		

6 - SWITCHING TIMES

The values indicated refer to a solenoid valve working with piloting pressure of 100 bar, with mineral oil at a temperature of 50°C, at viscosity of 36 cSt and with PA and BT connections.

The energizing and de-energizing times are obtained at the pressure variation which occurs on the lines.

TIMES ($\pm 10\%$) [ms]	ENERGIZED		DE-ENERGIZED	
	2 Pos.	3 Pos.	2 Pos.	3 Pos.
	AC solenoid	45	30	45
DC solenoid	75	60	60	45

7 - OPERATING LIMITS

The curves define the flow rate operating fields according to the valve pressure for the different spool types.

The values have been obtained according to ISO 6403 norm with solenoids at rated temperature and supplied with voltage equal to 90% of the nominal voltage.

The values have been obtained with mineral oil, viscosity 36 cSt at 50 °C, and filtration ISO 4406:1999 class 18/16/13.

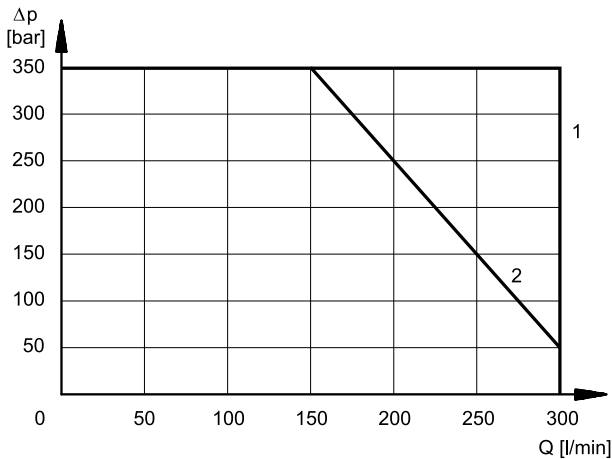

SPOOL	CURVE	
	P→A	P→B
S1,SA1,SB1	1	1
S2, SA2, SB2	1	1
S3, SA3, SB3	1	1
S4, SA4, SB4	2	2
S6	1	1
S7	2	2
S8	2	2
S9	1	1
S10	1	1
S11	1	1
S12	1	1
S20	1	1
S21	1	1

SPOOL	CURVE	
	P→A	P→B
TA, TB	1	1
TA02, TB02	1	1
23TA, 23TB	1	1
RK	1	1

8 - PERFORMANCE CHARACTERISTICS

PRESSURES [bar]	DSP7	DSP7H	DSC7	DSC7H
Max pressure in P, A, B ports	350	420	350	420
Max pressure in T line with external drainage	250	350	250	350
Max pressure in T line with internal drainage	210 (DC) 160 (AC)	210 (DC) 160 (AC)	-	-
Max pressure in Y line with external drainage	210 (DC) 160 (AC)	210 (DC) 160 (AC)	-	-
Min piloting pressure NOTE 1	5 ÷ 12			
Max piloting pressure NOTE 2	210	350	210	420

NOTE 1: minimum piloting pressure can be the lower range value at low flows rates, but with higher flow rates the higher value is needed.

NOTE 2: If the valve operates at higher pressures it is necessary to use the version with external pilot and reduced pressure. Otherwise, the valve can be ordered with internal pilot and pressure reducing valve with 30 bar fixed adjustment (pilot type Z, see identification code).

9 - PILOT AND DRAIN

Valves with electro-hydraulic actuation (DSP) are available with both pilot supply and drain internal or external type. The version with external drain allows a higher back pressure on the return line.

The valves with hydraulic actuation (DSC) are available with both pilot supply and pilot return external only.

NOTE: The pilot supply and drainage configuration must be chosen when ordering. Subsequent modification is only permitted by authorized experienced operators or at the factory.

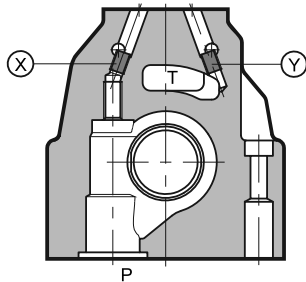

X: plug M5x6 for external pilot
Y: plug M5x6 for external drain

	TYPE OF VALVE	Plug assembly	
		X	Y
IE	internal pilot and external drain	NO	YES
II	internal pilot and internal drain	NO	NO
EE	external pilot and external drain	YES	YES
EI	external pilot and internal drain	YES	NO

9.1 - Backpressure valve incorporated on line P

Valves DSP7 are available upon request with backpressure valve incorporated on line P. This is necessary to obtain the piloting pressure when the control valve, in rest position, has the line P connected to the T port (spools S2, S4, S7, S8, S*2, S*4, TA02, TB02, RK02). The cracking pressure is of 5 bar with a minimum flow rate of 15 l/min.

Add **C** to the identification code for this request (see point 1).

In the C version the piloting is always internal.

The backpressure valve can be also delivered separately and it can be easily mounted on line P of the main control valve. Specify the code **0266577** to order the backpressure valve separately.

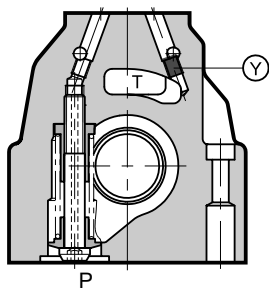
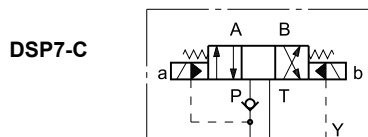

pilot always internal
Y: plug M5x6 for external drain

NOTE: the backpressure valve can't be used as check valve because it doesn't assure the seal.

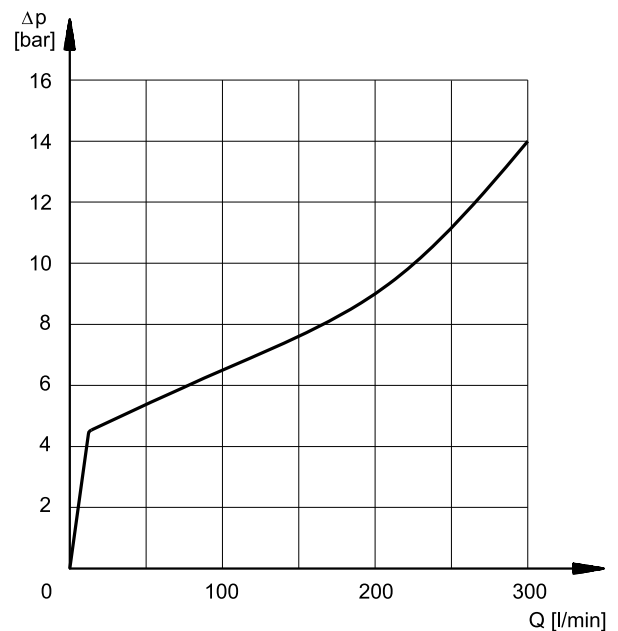

The curve refers to the pressure drop (body part only) with backpressure valve energized to which the pressure drop of the reference spool must be added. (see point 5)

10 - OPTIONS

10.1 - Control of the main spool stroke: C

Stroke control for the main spool is possible by means of special side covers so as to vary the maximum clearance opening.

This solution allows control of the flow rate from the pump to the actuator and from the actuator to the outlet, obtaining a double adjustable control on the actuator.

Add the letter **C** in the identification code to order this version (see point 1).

DSP7-S*/C

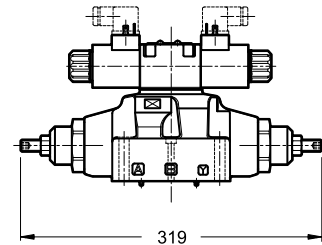

10.2 - Control of the main spool shifting speed: D

By placing a double flow control valve (QTM3 type) between the pilot solenoid valve and the main stage, the pilot supply flow can be adjusted and therefore the changeover smoothness can be varied.

Add the letter **D** in the identification code to order this version (see point 1).

DSP7-S*/D

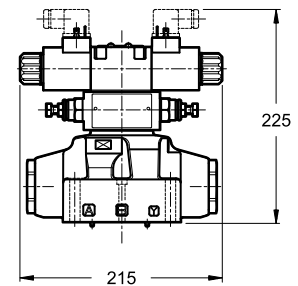

10.3 - Subplate with throttle on line P

It is possible to introduce a subplate with a restrictor of $\varnothing 0.8$ in line P between the pilot solenoid valve and the main stage. Subplate width 10 mm.

Add **P08** in the identification code to order this version (see point 1).

DSP7-S*/P08

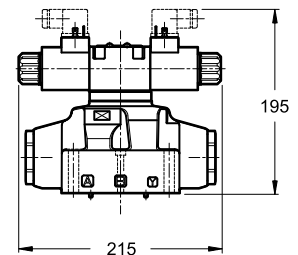

10.4 - Pilot stage with S2 spool

This version is used in association with the external type pilot to allow the pilot line to be unloaded when the valve is in the normal position.

The pilot supply must be external type (E).

Add **S2** to the identification code to order this option (see point 1).

10.5 - Control of the main spool stroke and of the shifting speed: C-D

It is possible to have the valve fitted with both the main spool stroke control (C option) and the main spool shifting speed control (D option)

Add **C-D** in the identification code to order this version (see point 1).

11 - ELECTRICAL FEATURES

11.1 - Solenoids

These are essentially made up of two parts: tube and coil. The tube is threaded into the valve body and includes the armature that moves immersed in oil, without wear. The inner part, in contact with the oil in the return line, ensures heat dissipation.

The coil is fastened to the tube by a threaded ring, and can be rotated 360°, to suit the available space.

Protection from atmospheric agents IEC 60529

The IP protection degree is guaranteed only with both valve and connectors of an equivalent IP degree, correctly connected and installed.

electric connection	electric connection protection	whole valve protection
K1	IP65	IP65
K7	IP65/67	

SUPPLY VOLTAGE FLUCTUATION	± 10% Vnom
MAX SWITCH ON FREQUENCY	10.000 ins/hour
DUTY CYCLE	100%
ELECTROMAGNETIC COMPATIBILITY (EMC) (NOTE)	In compliance with 2014/30/EU
LOW VOLTAGE	In compliance with 2014/35/EU
CLASS OF PROTECTION Coil insulation (VDE 0580) Impregnation: DC valve AC valve	class H class F class H

NOTE: In order to further reduce the emissions with DC supply, the use of type H connectors is recommended. These prevent voltage peaks on opening of the coil supply electrical circuit (see cat. 49 000).

11.2 - DC coils

In direct current energizing, current consumption stays at fairly constant values, essentially determined by Ohm's law: $V = R \times I$.

The WK1 and WK7D are coils specific for the high corrosion resistance version of the valve.

The WK7D coil includes a suppressor diode of pulses for protection from voltage peaks during switching. During the switching the diode significantly reduces the energy released by the winding, by limiting the voltage to 31.4V in the D12 coil and to 58.9 V in the D24 coil.

Using connectors type 'D' or 'D1' (see cat. 49 000) with embedded bridge rectifier it is possible to feed DC coils with alternating current (50 or 60 Hz), considering a reduction of the operating limits (see point 6).

The table shows current and power consumption values for DC coils.

(values ±10%)

	Nominal voltage [V]	Resistance at 20°C [Ω]	Current consumption [A]	Power consumption [W]	Coil code	
					K1	K7
D12	12	4,4	2,72	32,7	1903080	1902940
D24	24	18,6	1,29	31	1903081	1902941
D48	48	78,6	0,61	29,5	1903083	
D110	110	436	0,26	28,2	1903464	
D220	220	1758	0,13	28,2	1903465	

11.3 - AC coils

The table shows current and power consumption values at inrush and at holding, relevant to the different coil types for AC current.

Coils for alternating current (values ± 5%)

Suffix	Nominal Voltage [V]	Freq. [Hz]	Resistance at 20°C [Ω]	Current consumption at inrush [A]	Current consumption at holding [A]	Power consumption at inrush [VA]	Power consumption at holding [VA]	Coil availability K1
A24	24	50	1.69	5.81	1.32	139	32	1902830
A48	48		6.02	3.78	0.86	182	41	1902831
A110	110V-50Hz 120V-60Hz	50/60	33	1.76	0.40	194	44	1902832
				1.54	0.35	185	42	
A230	230V-50Hz 240V-60Hz		135	0.92	0.21	213	48	1902833
				0.79	0.18	190	43	
F110	110	60	28.5	1.45	0.33	160	36	1902834
F220	220		103	0.92	0.21	203	46	1902835

12 - DSP7 OVERALL AND MOUNTING DIMENSIONS FOR SOLENOID DISTRIBUTOR

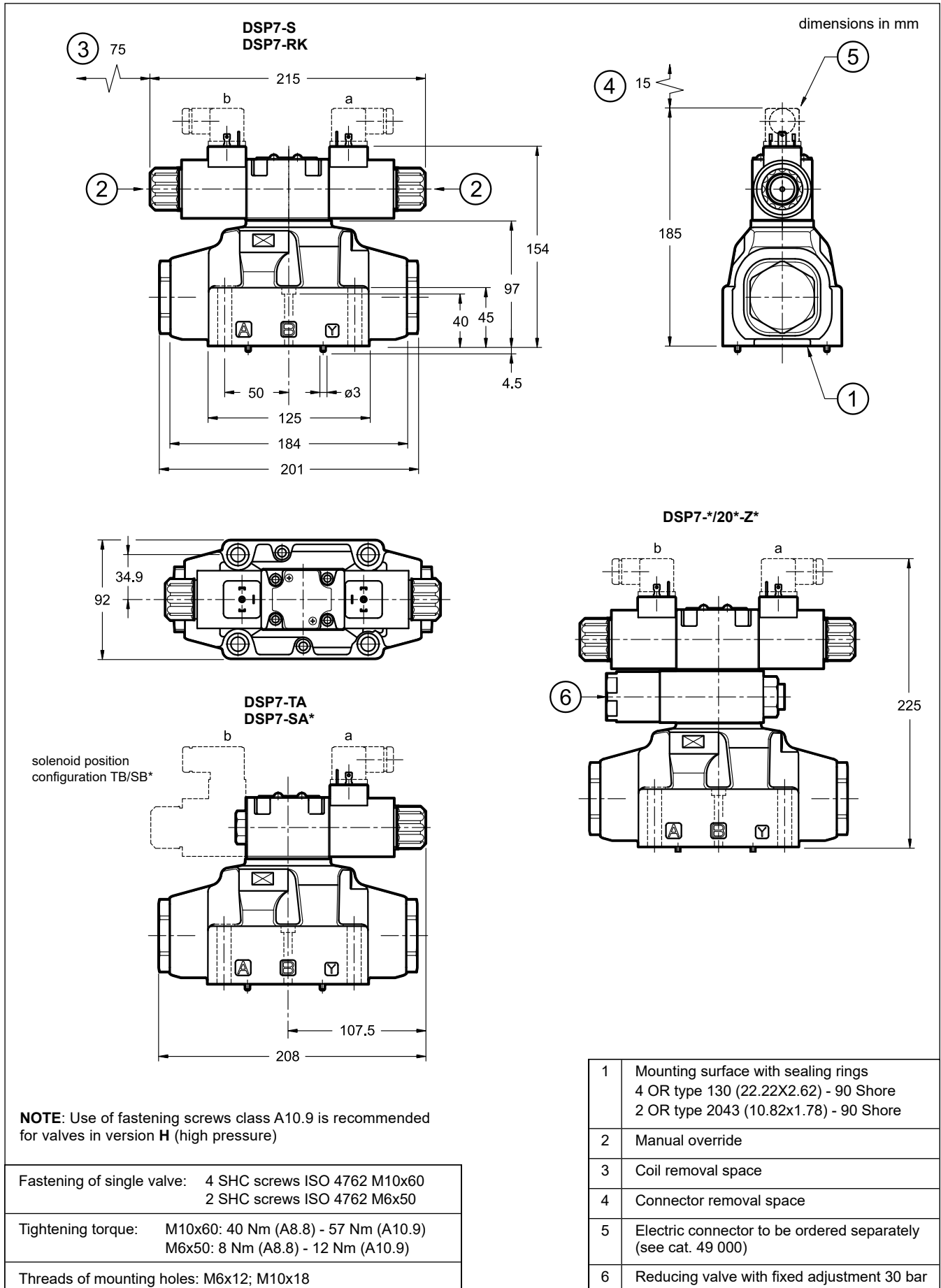

13 - DSC7 OVERALL AND MOUNTING DIMENSIONS FOR HYDRAULIC DISTRIBUTOR DSC7

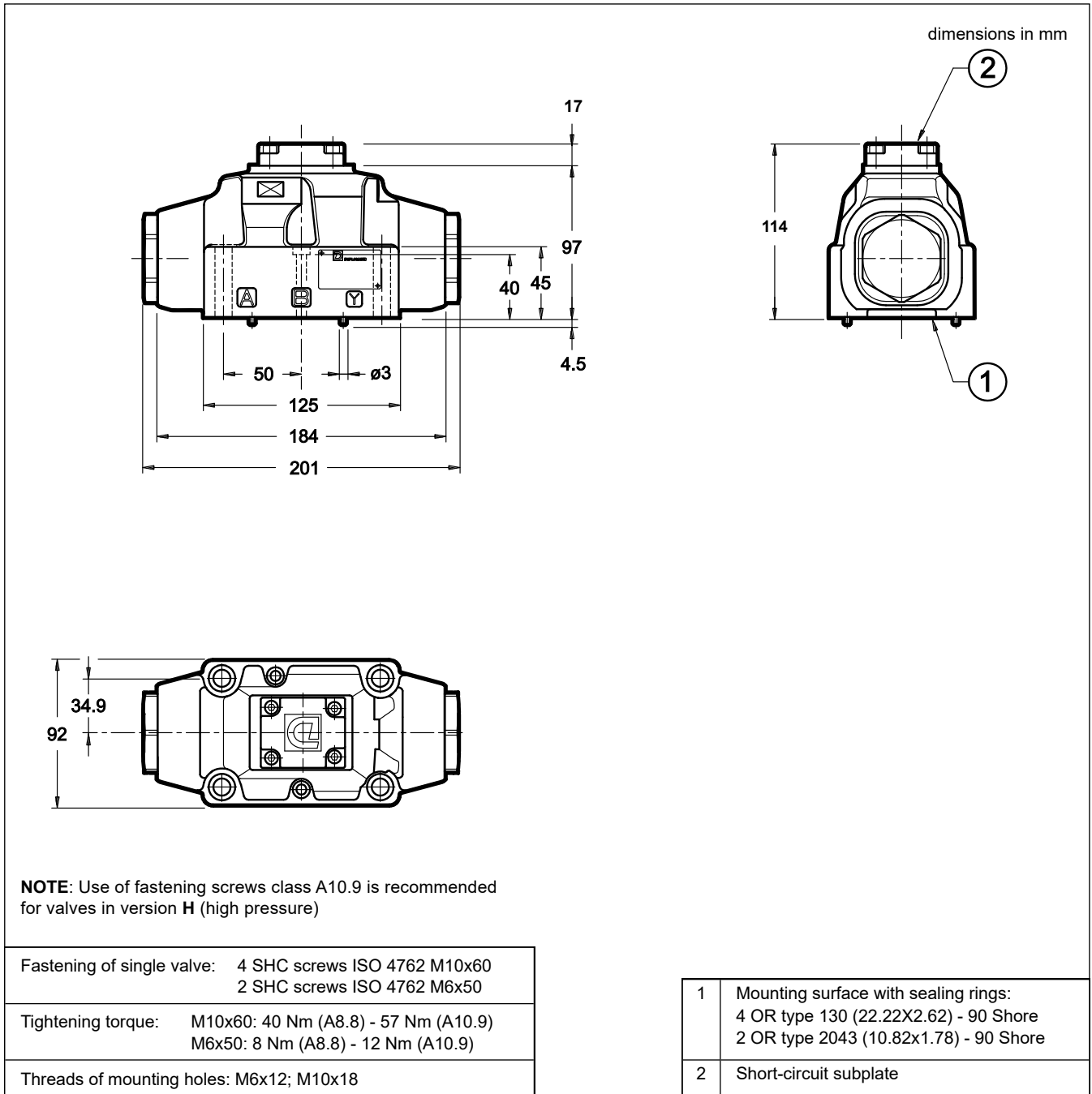

14 - INSTALLATION

Configurations with centring and recall springs can be mounted in any position; type RK valves - without springs and with mechanical detent - must be mounted with the longitudinal axis horizontal.

Valve fastening takes place by means of screws or tie rods, laying the valve on a lapped surface, with values of planarity and smoothness that are equal to or better than those indicated in the drawing. If the minimum values of planarity or smoothness are not met, fluid leakages between valve and mounting surface can easily occur.

NOTE: Use of fastening screws class 10.9 is recommended for valves in version H (high pressure).

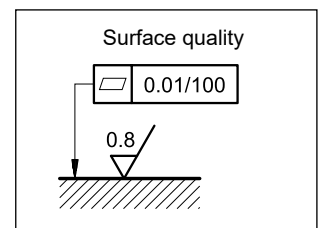

15 - ELECTRIC CONNECTIONS

connection for EN 175301-803
(ex DIN 43650) connector
code **K1 (standard)**
code **WK1** (W7 version only)

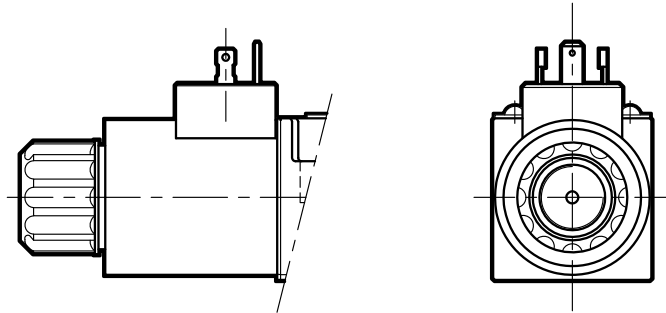

connection for
DEUTSCH DT06-2S male
connector type
code **K7**

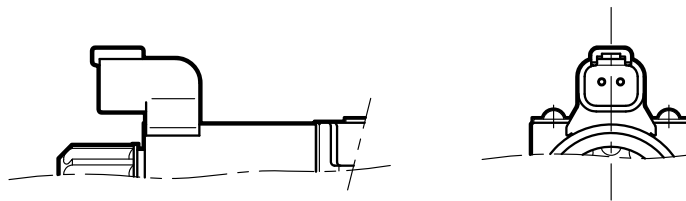

connection for
DEUTSCH DT06-2S male connector
code **WK7** (W7 version only)
code **WK7D** (W7 version only - coil
with diode)

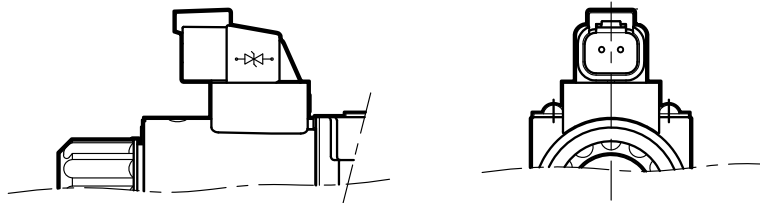

16 - ELECTRIC CONNECTORS

Solenoid valves are delivered without connectors. Connectors type EN 175301-803 (ex DIN 43650) for K1 and WK1 connections can be ordered separately. See catalogue 49 000.

17 - MANUAL OVERRIDE

Whenever the solenoid valve installation may involve exposure to atmospheric agents or use in tropical climates, the manual override, boot protection is recommended.

Add the suffix **CM** to request this device (see point 1).

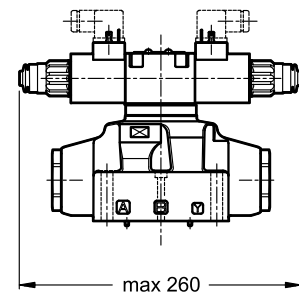

18 - HIGH IP DEGREE AND CORROSION RESISTANCE VERSION

These versions are available only for the basic valve and for the valves with D and S2 control options (see point 10). The boot manual override (CM) is installed as standard in order to protect the solenoid tube.

18.1 - Identification code

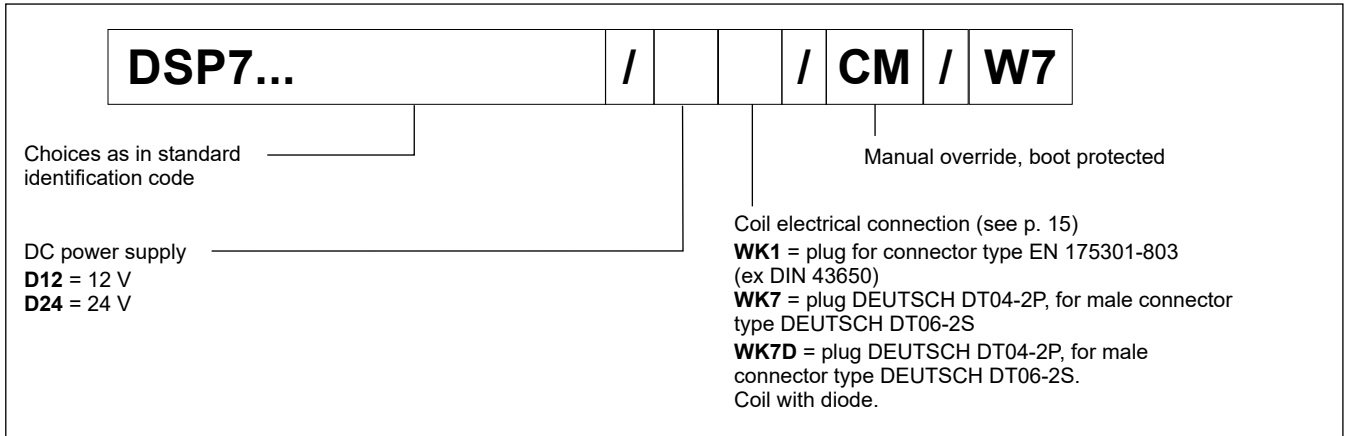

18.2 - Corrosion resistance

This version features the zinc-nickel coating on all exposed metal parts of the valve, making it resistant to exposure to the salt spray for **600** hours (test performed according to UNI EN ISO 9227 and assessment test performed according to UNI EN ISO 10289).

18.3 - DC coils

The coils feature a zinc-nickel surface treatment.

The WK7D coil includes a suppressor diode of pulses for protection from voltage peaks during switching. During the switching the diode significantly reduces the energy released by the winding, by limiting the voltage to 31.4V in the D12 coil and to 58.9 V in the D24 coil.

(values $\pm 10\%$)

	Nominal voltage [V]	Resistance at 20°C [Ω]	Current consumpt. [A]	Power consumpt [W]	Coil code		
					WK1	WK7	WK7D
D12	12	4.4	2.72	32.7	3984000001	3984000101	3984000111
D24	24	18.6	1.29	31	3984000002	3984000102	3984000112

18.4 - Protection from atmospheric agents IEC 60529

The IP protection degree is guaranteed only with both valve and connectors of an equivalent IP degree, correctly connected and installed.

electric connection	electric connection protection	whole valve protection
WK1	IP66	IP66
WK7	IP66/IP68/IP69 IP69K*	IP66/IP68/IP69 IP69K*
WK7D	IP66/IP68/IP69 IP69K*	IP66/IP68/IP69 IP69K*

(*) The IP69K protection degree is not taken into account in IEC 60529 but it is included in ISO 20653.

NOTE: As regards the liquid ingress protection (second digit), there are three means of protection.

Codes from 1 to 6 are related to water jets.

Rates 7 and 8 are related to immersion.

Rate 9 is reserved for high pressure and temperature water jets.

This means that IPX6 covers all the lower steps, rate IPX8 covers IPX7 but not IPX6 and lower, instead IPX9 does not cover any of them.

Whether a device meets two types of protection requirements it must be indicated by listing both the tests separated by a slash.

(E.g. a marking of an equipment covered both by temporary immersion and water jets is IP66/IP68).



18 - SUBPLATES

(see catalogue 51 000)

These subplates are not suitable for DS*7H high pressure valves.

Type with rear ports	PME07-AI6G
Type with side ports	PME07-AL6G
P, T, A, B, port dimensions X, Y; L port dimensions	1" BSP 1/4" BSP