

CONNECTORS AND CABLE SETS

FOR VALVES WITH INTEGRATED ELECTRONICS

MATING CONNECTORS FOR MAIN CONNECTION

1 - FOR K11 CONNECTION - 6 PIN+PE

name: EX7S/L/10 **code: 3890000003**

metal connector 6-poles + PE, female, IP67
 standard: MIL-C-5015-G (EN 175201-804)
 suitable cables: Ø11 mm; up to 20 metres length
 wire sizes: cross section 1 mm²
 contacts: either solder or crimp
 shield arranged: yes

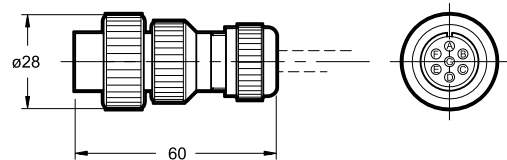

name: EX7S/L/10/4015 **code: 3890000012**

metal connector 6-poles + PE, female, IP67
 standard: MIL-C-5015-G (EN 175201-804)
 suitable cables: Ø18 mm, up to 40 metres length
 conductor size: from 0.75 to 1.5 mm²
 contacts: crimp contacts (included)
 shield arranged: yes

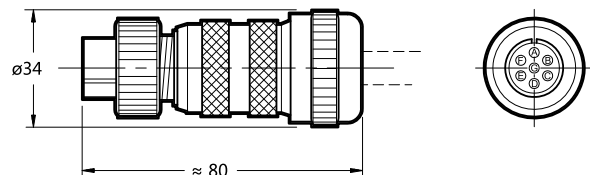

2 - FOR K12 CONNECTION - M12 5 PIN

name: EC5S/M12L/10 **code: 3491001001**

M12 connector, 5-poles, code A, female, IP65/67
 glass filled plastic
 standard: IEC 61076-2-101
 suitable cables: Ø9 mm, up to 20 metres length
 conductor size: 0.75 mm²
 contacts: screw contacts
 shield: yes

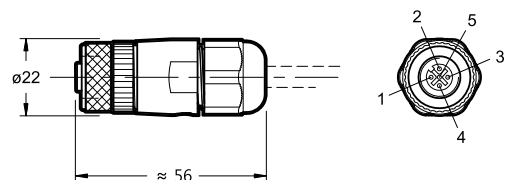

3 - FOR K16 CONNECTION - 11 PIN+PE

name: EX12S/L/10 **code: 3890000004**

Metal connector 11 poles + PE, shielded
 standard: DIN 43651 (EN 175201-804)
 suitable cables: Ø15 mm up to 10 metres length
 conductor size: max 0.5 mm²
 contacts: crimp contacts

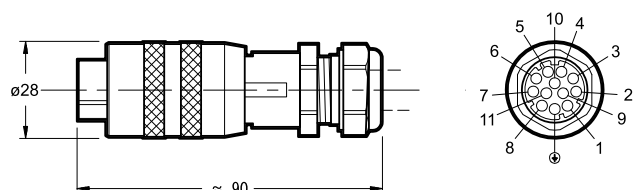



4 - MATING CONNECTORS FOR FIELDBUS COMMUNICATION

We offer metal connectors IEC 61076-2-101, shielded, with screw connection, IP 67, for fieldbus communication EtherCAT, Ethernet/IP, Profinet and Powerlink.

name: EX4P/M12DL/10 **code 3890000009**

connector M12 D 4 pin; external cable diameter 4 ± 6 mm
(X2, X3) male

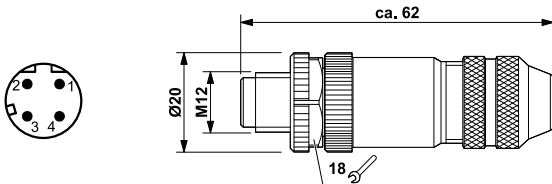

5 - TRANSDUCER MATING CONNECTORS

name: EX8P/M12AL/10 **code 3890000011**

connector for digital sensor type SSI / Encoder M12 A 8 pin
external cable diameter 6 ± 8 mm
(X7) male

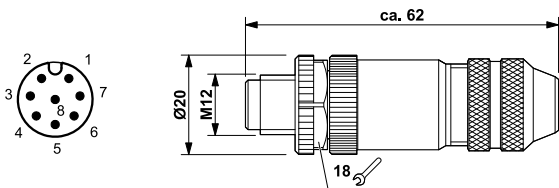

name: EX4P/M12AL/10 **code 3890000010**

connector for analogue sensor M12 A 4 pin
external cable diameter 4 ± 6 mm
(X4) male

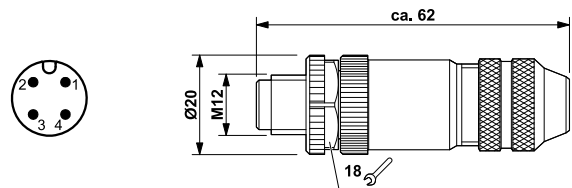

6 - PROTECTIVE CAPS FOR M12 CONNECTIONS

The use of caps is recommended to protect unused M12 electrical connections and to guarantee the declared IP degree of the valves.

cap for female connection **code 0672218**

cap for male connection **code 0238914**

7 - CABLE SETS

We can supply cable sets for fieldbus communication connections X3 to X2 and sensor cables for X7 and X4 ports on request.

All cables are PUR halogen-free.

These molded cables are equipped with 'speed connect' connectors that allow a smaller overall than conventional connectors.

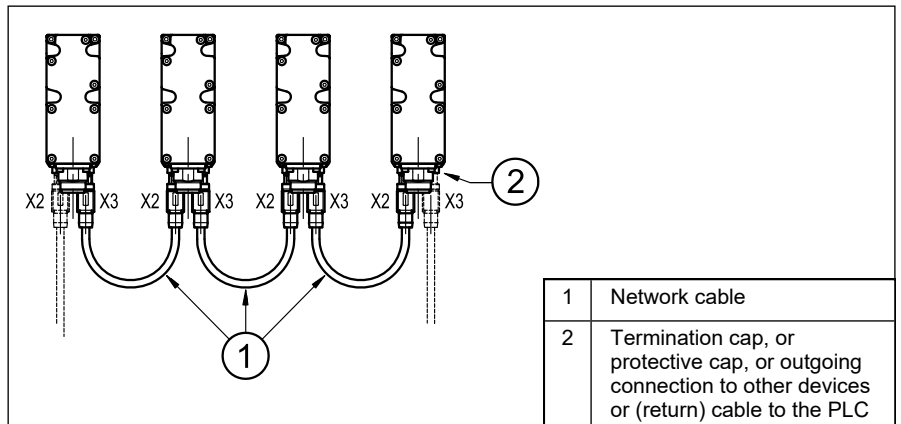

7.1 - Fieldbus cables X3 to X2

Fieldbus type	Cable description
Ethernet:	Network cable, Ethernet CAT5 (100 Mbps), shielded.
EtherCAT	cable length: 0.5 m
Ethernet/IP	Plug straight M12 code D - plug straight M12 code D,
Profinet	IP67
Powerlink	ambient temperature: -25 ÷ 85 °C

Circuit diagram

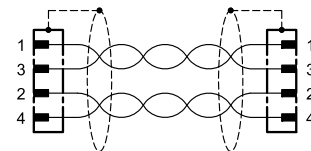

code: 3890001003

7.2 - Sensor / actuator cables

Sensor type	Cable description
Analogue (X4)	Sensor/actuator cable
code: 3890001004	cable length: 0.6 m
	Plug straight M12 code A - double socket straight M12 code A
	IP65 / IP67
	ambient temperature: -25 ÷ 90 °C

Circuit diagram



Digital SSI / Encoder (X7)	Sensor/actuator cable, shielded,
code: 3890001005	cable length: 3 m
	Plug straight M12 code A - free cable end, unwired
	ambient temperature: -25 ÷ 90 °C

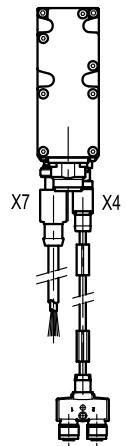
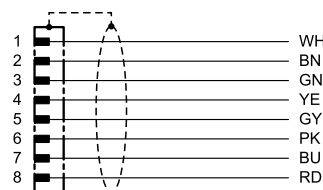



DIPLOMATIC MS Spa

via Mario Re Depaulini, 24 | 20015 Parabiago (MI) | Italy

T +39 0331 895111 | E vendite.ita@diplomatic.com | sales.exp@diplomatic.com
diplomaticmotionsolutions.com