

# MZE

## PILOT OPERATED PRESSURE REDUCING VALVE WITH ELECTRIC PROPORTIONAL CONTROL

### SERIES 58

**MODULAR VERSION  
ISO 4401-03**

**p** max **320** bar  
**Q** max (see table of performances)

#### MOUNTING SURFACE

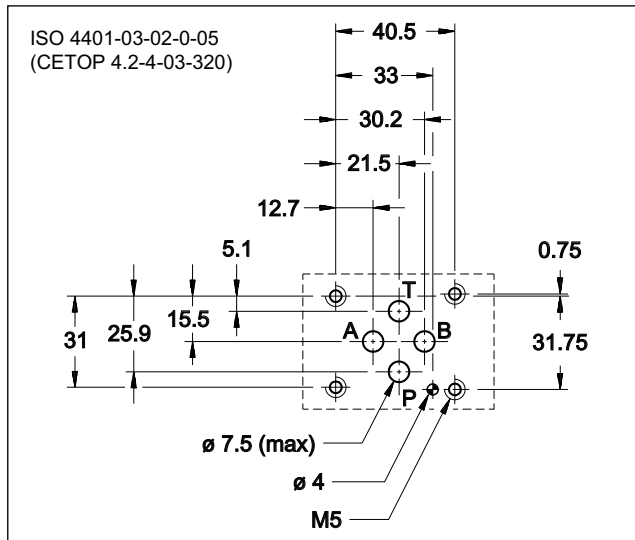

#### PERFORMANCES

(obtained with mineral oil with viscosity of 36 cSt at 50°C and electronic control card)

Maximum operating pressure: - P-A-B ports - T port	bar	320 2
Minimum controlled pressure	see $\Delta p$ -Q diagram	
Maximum flow in P line Maximum flow on passing lines Drain flow	l/min	30 50 0,4
Step response	see paragraph 5	
Hysteresis (with PWM 200 Hz)	% of p nom	< 3%
Repeatability	% of p nom	< $\pm 1,5\%$
Electrical characteristic	see paragraph 4	
Ambient temperature range	°C	-20 / +50
Fluid temperature range	°C	-20 / +80
Fluid viscosity range	cSt	10 ÷ 400
Fluid contamination degree	According to ISO 4406:1999 class 18/16/13	
Recommended viscosity	cSt	25
Mass	kg	1,8

#### OPERATING PRINCIPLE

- MZE valves are 3-way pilot operated pressure reducing valves, with electric proportional control, designed as modular versions with mounting interface in compliance with ISO 4401) standards.
- The valves are used to reduce pressure in the secondary circuit branches thus ensuring stability of controlled pressure in the event of variations of the flow rate through the valve.
- Pressure can be modulated continuously in proportion to the current supplied to the solenoid.
- The valve can be controlled directly by a current control supply unit or by an electronic control unit, to exploit valve performance to the full (see par. 8).
- The valve is available in three different pressure reduction ranges of up to 230 bar.
- The valve is available only with internal drain to the T line inside the valve.

#### HYDRAULIC SYMBOL

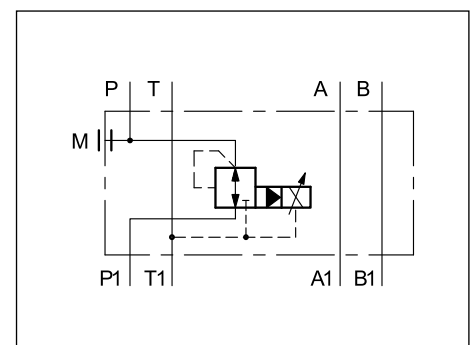

## 1 - IDENTIFICATION CODE

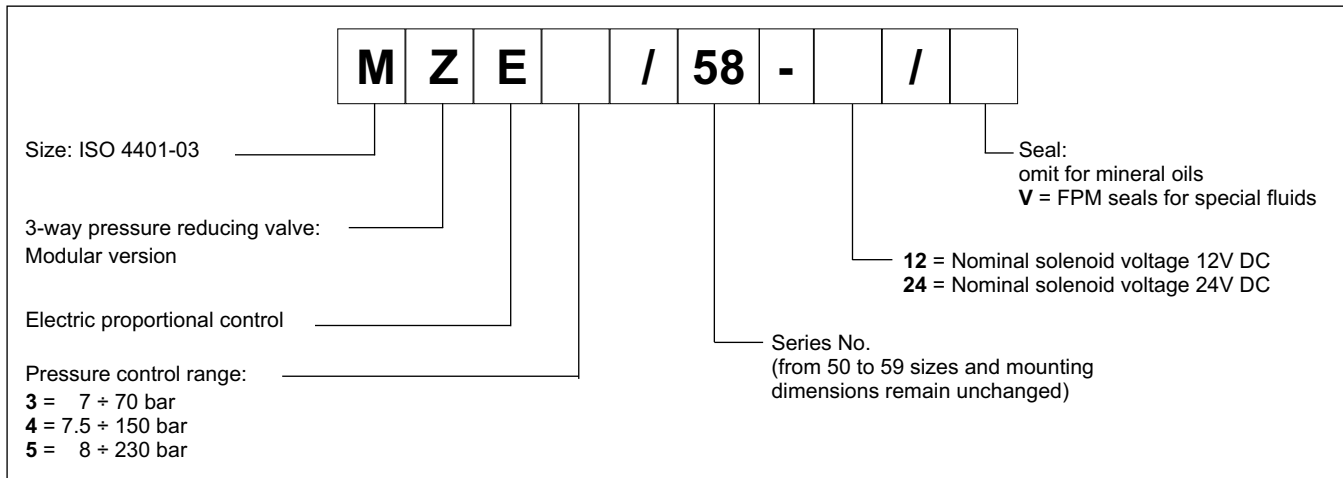

## 2 - CHARACTERISTIC CURVES

(measured with viscosity 36 cSt at 50°C)

**PRESSURE CONTROL  $p = f(I)$**

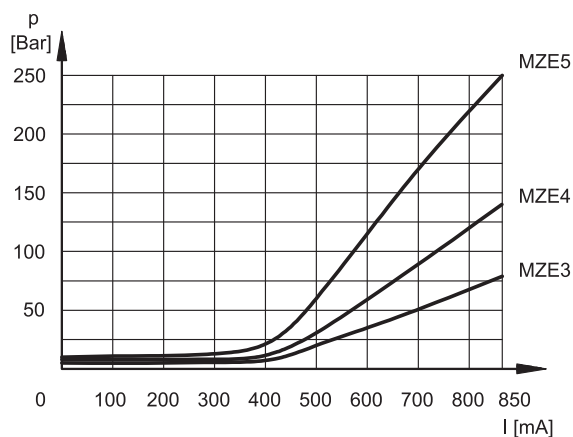

The curves have been obtained with working lines closed (without flow).

**PRESSURE VARIATION  $p = f(Q)$**

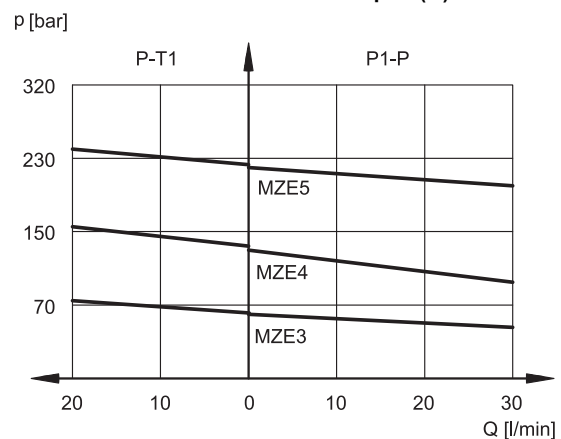

The curves have been obtained with inlet pressure 50 bar greater than nominal pressure. Pressure values in P1 greater than 50 bar reduce flow values considerably.

**PRESSURE DROP  $\Delta p = f(Q)$**

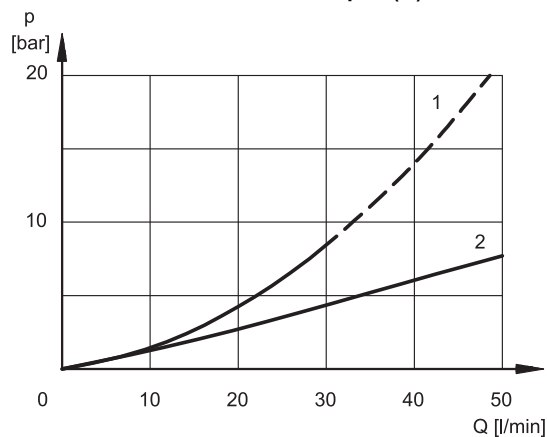

1. pressure drops P1 → P
2. pressure drop in passing lines  
(ex. A ↔ A1)

### 3 - HYDRAULIC FLUIDS

Use mineral oil-based hydraulic fluids HL or HM type, according to ISO 6743-4. For these fluids, use NBR seals.

For fluids HFDR type (phosphate esters) use FPM seals (code V).

For the use of other fluid types such as HFA, HFB, HFC, please consult our technical department.

Using fluids at temperatures higher than 80 °C causes a faster degradation of the fluid and of the seals characteristics.

The fluid must be preserved in its physical and chemical characteristics.

### 4 - ELECTRICAL CHARACTERISTICS

#### Proportional solenoid

The proportional solenoid comprises two parts: tube and coil.

The tube, screwed to the valve body, contains the armature which is designed to maintain friction to a minimum thereby reducing hysteresis.

The coil is mounted on the tube secured by means of a lock nut and can be rotated through 360° depending on installation clearances.

<b>NOMINAL VOLTAGE</b>	V DC	<b>12</b>	<b>24</b>
<b>RESISTANCE (at 20°C)</b>	Ω	3.66	16.6
<b>MAXIMUM CURRENT</b>	A	1.9	0.85
<b>DUTY CYCLE</b>		100%	
<b>ELECTROMAGNETIC COMPATIBILITY (EMC)</b>	According to 2014/30/EU		
<b>CLASS OF PROTECTION:</b> Atmospheric agents (IEC EN 60529)	IP 65		

### 5 - STEP RESPONSE

(obtained with mineral oil with viscosity of 36 cSt at 50°C and electronic control card)

Step response is the time taken for the valve to reach 90% of the set pressure value following a step change of reference signal.

The table illustrates typical step response times measured with input flow rate of Q = 25 l/min.

<b>REFERENCE SIGNAL STEP</b>	0 → 100%	100 → 0%
Step response [ms]	100	80

### 6 - INSTALLATION

We recommend that MZE valves should be installed either in horizontal position, or vertical position with the solenoid downward. If the valve is installed in vertical position and with the solenoid upward, you must consider possible variations of the minimum controlled pressure, if compared to what is indicated in paragraph 2.

Ensure that there is no air in the hydraulic circuit. In particular applications, it can be necessary to vent the air entrapped in the solenoid tube, by using the apposite drain screw in the solenoid tube. Ensure that the solenoid tube is always filled with oil (see par.7). At the end of the operation, make sure of having screwed correctly the drain screw.

Connect the valve T port directly to the tank. Add any backpressure value detected in the T line to the reduced pressure value.

**The maximum admissible backpressure in the T line, under operational conditions, is 2 bar.**

Valves are fixed by means of screws or tie rods on a flat surface with planarity and roughness equal to or better than those indicated in the relative symbols. If minimum values are not observed fluid can easily leak between the valve and support surface.

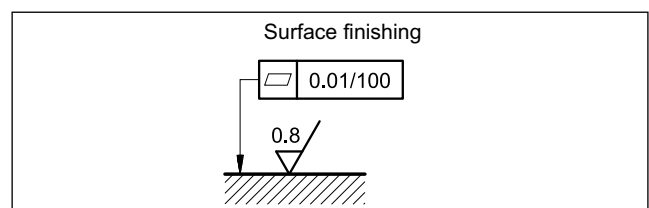

## 7 - OVERALL AND MOUNTING DIMENSIONS

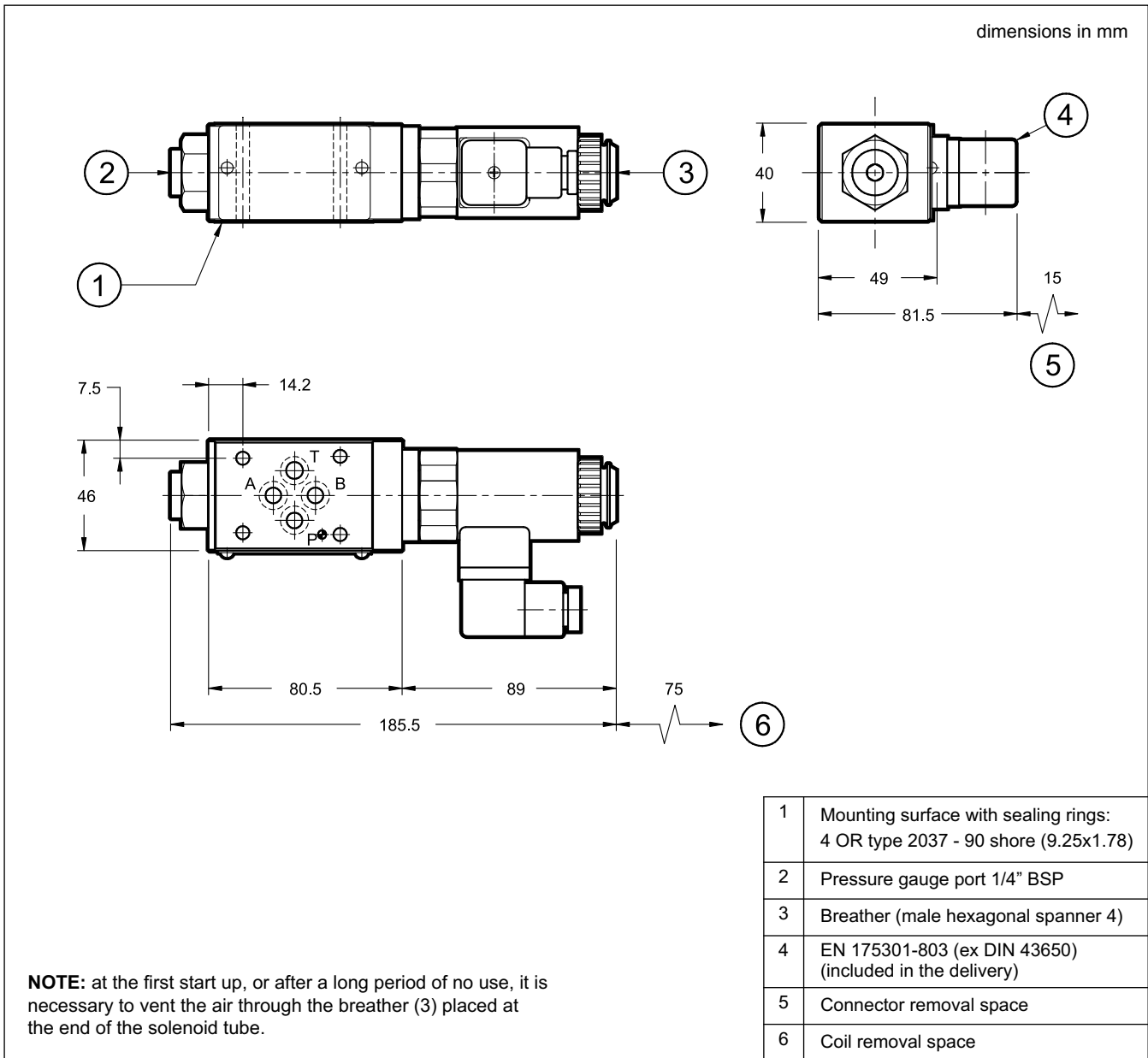

## 8 - ELECTRONIC CONTROL UNITS

<b>EDC-112</b>	for solenoid 24V DC	plug version	see cat. 89 120
<b>EDC-142</b>	for solenoid 12V DC		
<b>EDM-M112</b>	for solenoid 24V DC	DIN EN 50022 rail mounting	see cat. 89 251
<b>EDM-M142</b>	for solenoid 12V DC		